

aanzicht exterior

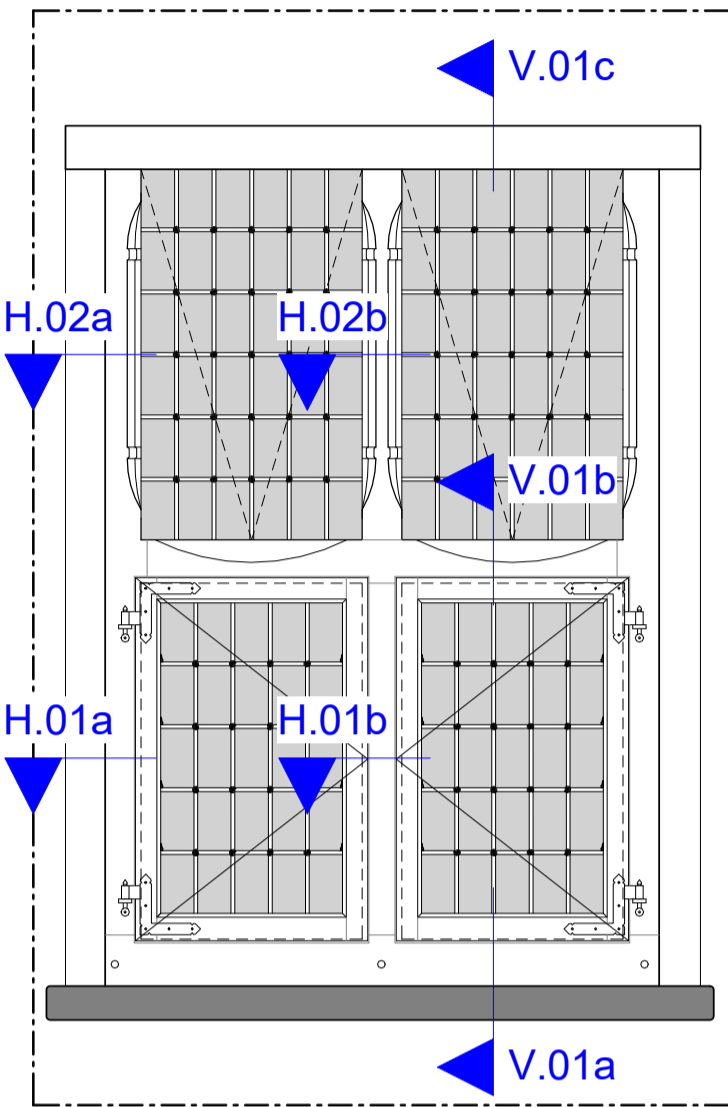

aanzicht interieur

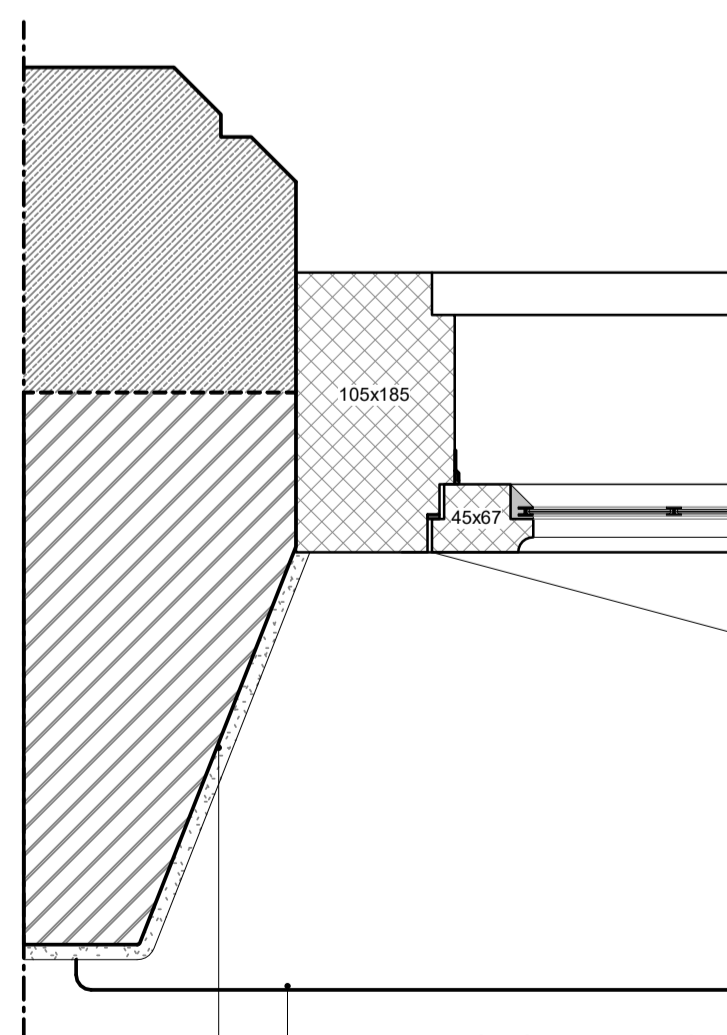
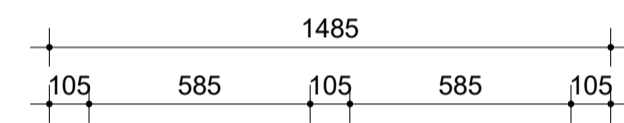
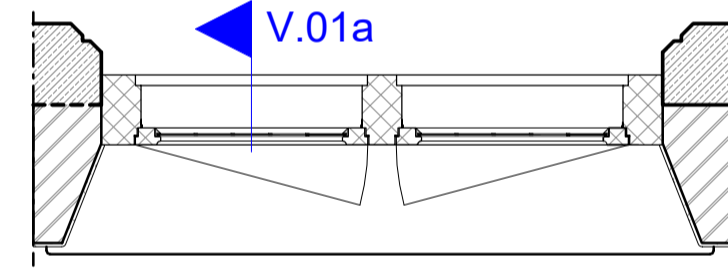
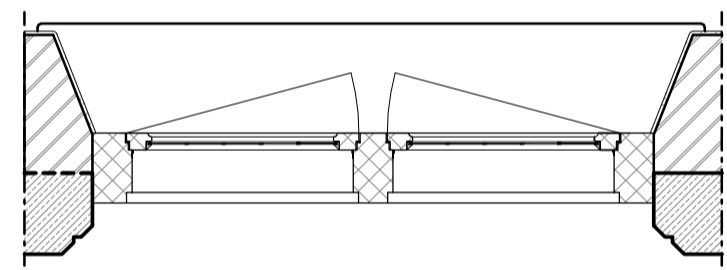
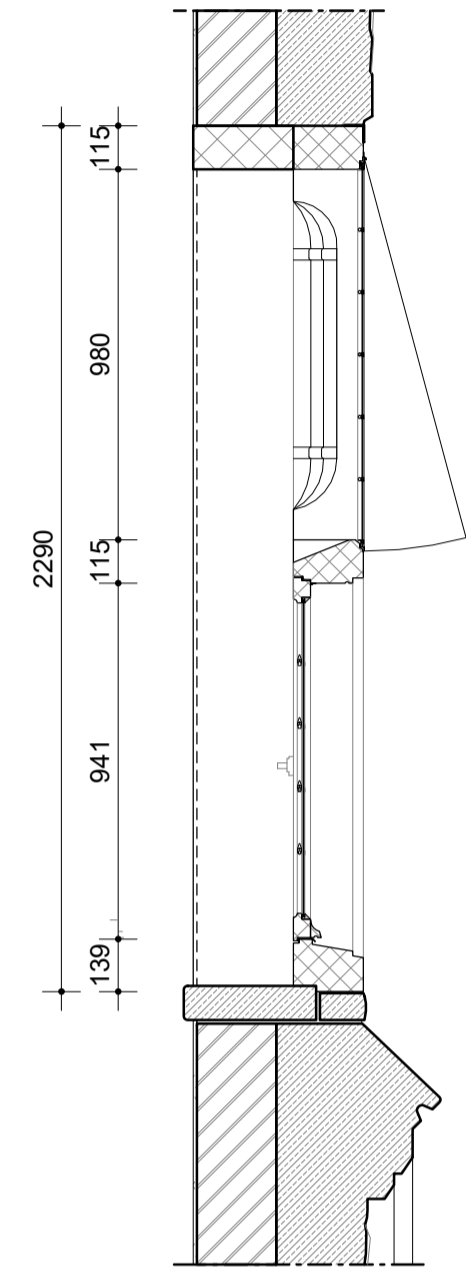

H.01a hardsteen vensterbank naaddichting

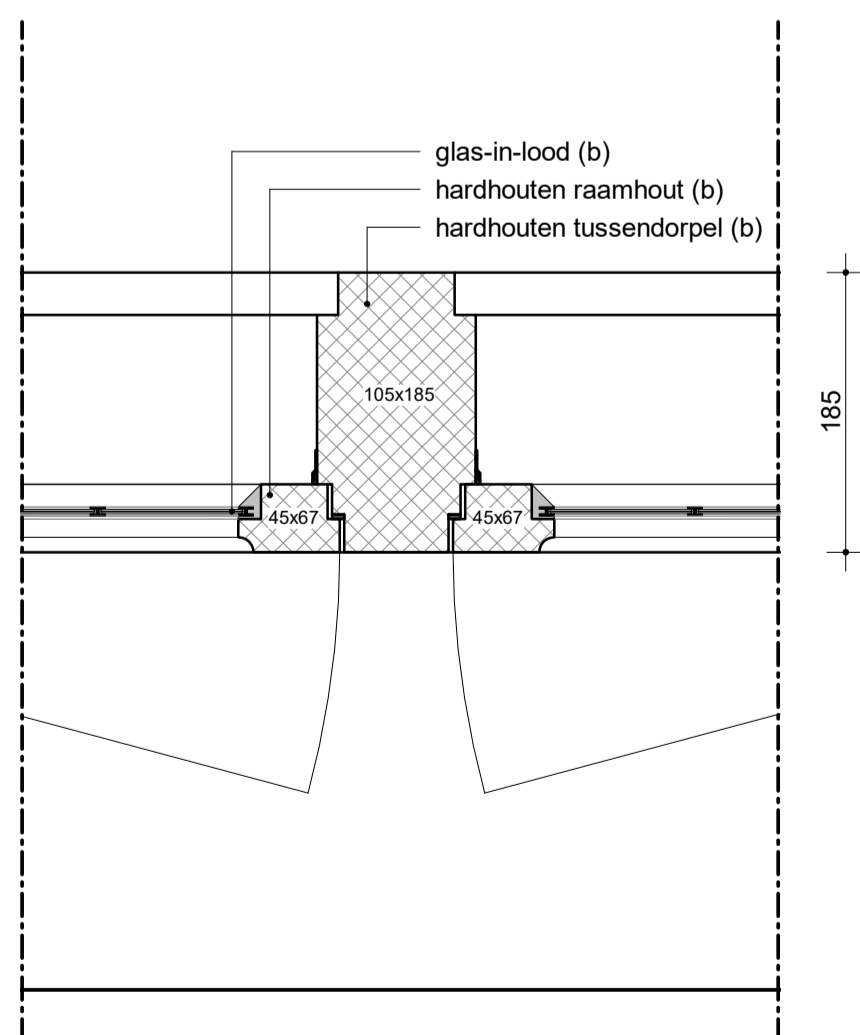

H.01b glas-in-lood (b) hardhouten raamhout (b) hardhouten tussendorpel (b)

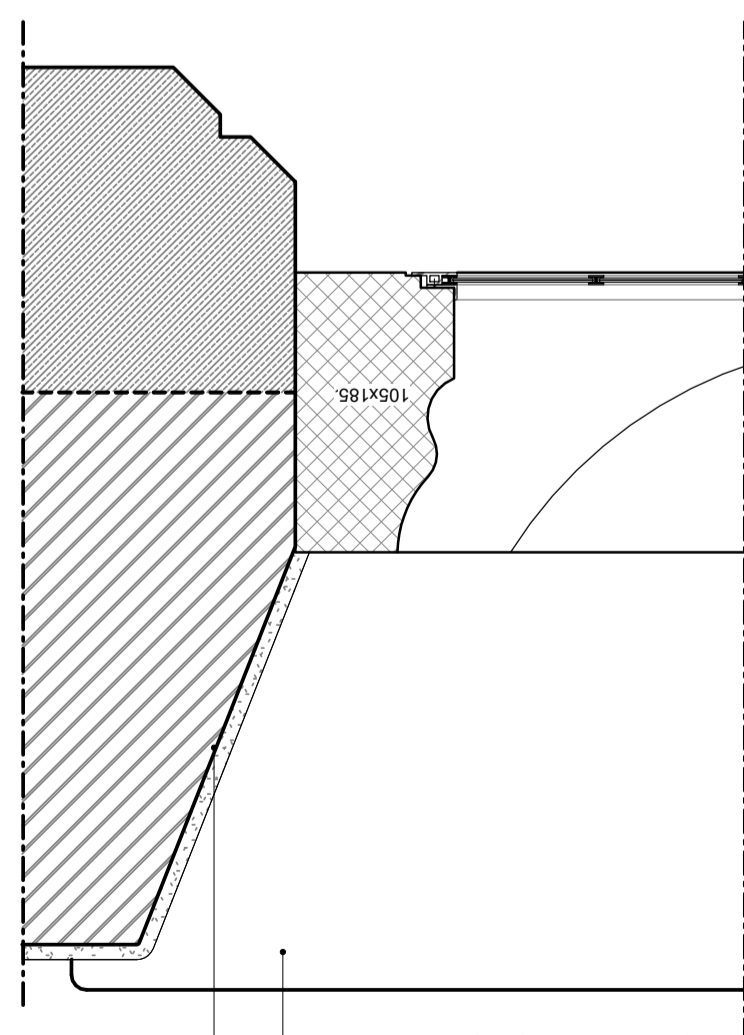

H.02a hardsteen vensterbank naaddichting

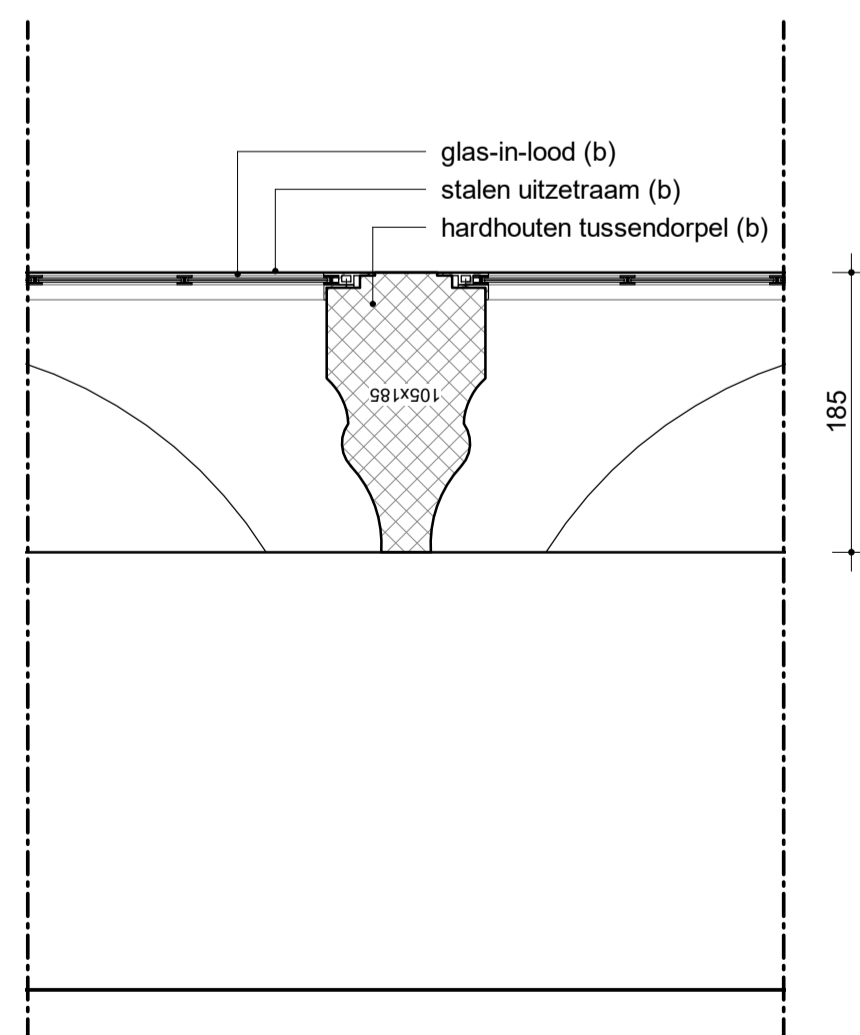

H.02b glas-in-lood (b) stalen uitzetraum (b) hardhouten tussendorpel (b)

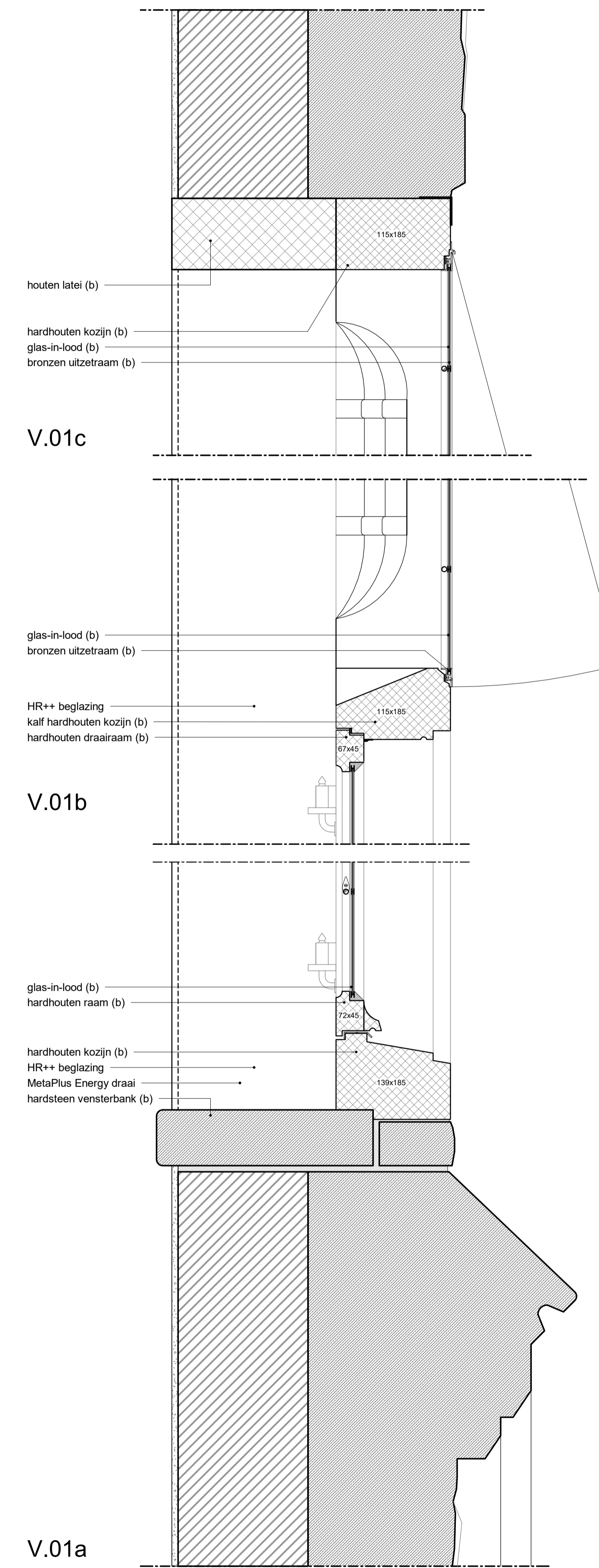

V.01a

MAATVOERING IN HET WERK CONTROLEREN

Project : Stadhuis Gouda
Adres : Markt 1, 2801 JG Gouda
Projectnr. : 22_2269
Tekening : BT-18
Opname kozijntype 1
Bestaande toestand
Schaal : 1:5/20 (A1)
Status : AANVR. OMG.VERGUNNING
Datum : 07-09-2023



Westsingel 9
3811 BA Amersfoort
bureau@vanhoogest.nl
T 0031 33 4631705